

MODEL FSUGHP8
HIGH PRESSURE GROOVED FLEXIBLE CONNECTOR
±8" MOVEMENT

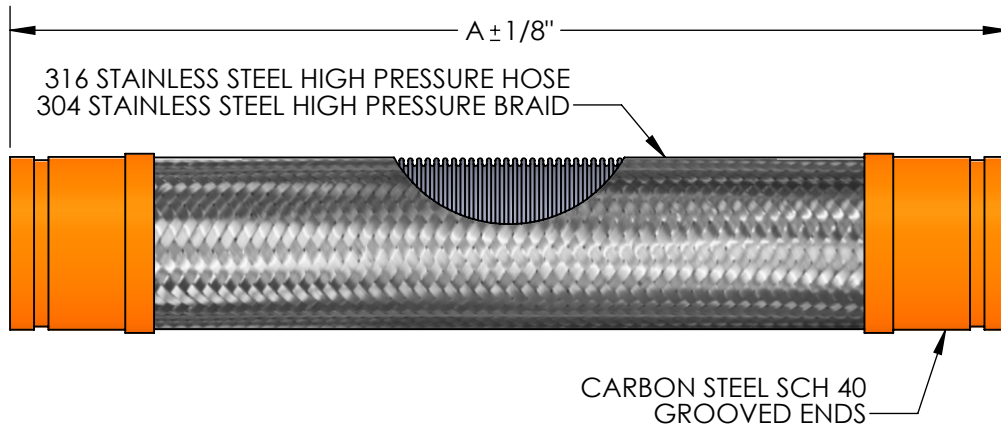

QTY	PART NUMBER	PIPE SIZE	A	BRAID	PRESSURE RATING (PSI)*	INTERMITTENT LATERAL OFFSET
	FSUGHP80400	4"	54-3/4"	DOUBLE	300	±8"
	FSUGHP80500	5"	50-1/4"	DOUBLE	300	±8"
	FSUGHP80600	6"	59-1/4"	DOUBLE	300	±8"

SUITABLE FOR USE IN DRY PIPE SYSTEMS
 TEMPERATURES TO -40°F.

*FOR SAFE WORKING PRESSURE ABOVE 70°F,
 MULTIPLY THE PRESSURE SHOWN AT 70°F
 TIMES THE CORRECTION FACTOR OF THE
 REQUIRED TEMPERATURE.

TEMPERATURE (°F)	FACTOR
70	1.0
200	.91
300	.85
400	.78
500	.77
600	.76

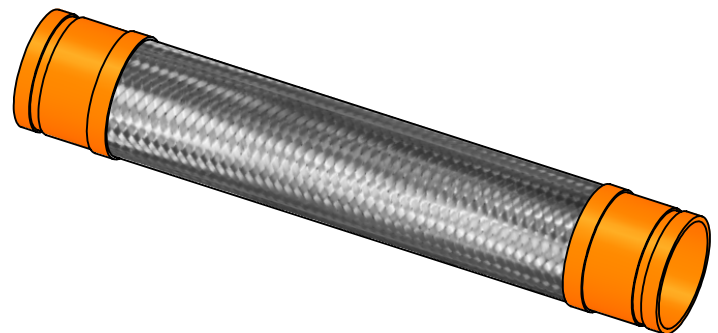

NSF 372 - LEAD FREE

The wetted surface of this product contacted by consumable water contains less than one quarter of one percent (0.25%) of lead by weight. Material complies with state codes and standards, where applicable, requiring reduced lead content.

CUSTOMER: _____

PROJECT: _____

ENGINEER: _____

REV.	DATE
	
2323 W. HUBBARD ST. CHICAGO, IL 60612 TEL: 312-738-3800 FAX: 312-738-0415 WWW.METRAFLEX.COM	
MODEL FSUGHP8 UL LISTED GROOVED FLEXIBLE CONNECTOR FOR FIRE PROTECTION, ±8" MOVEMENT, HP H&B	
DRAWN BY: DEVINR	DATE: 01/03/2023
APPROVED:	DATE:
SCALE: N/A	DRAWING NUMBER: FSUGHP8